

HORSE CLUB™



schleich®

42591



+



10162421

# 42591

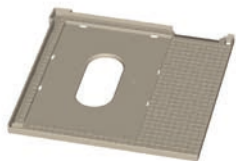

10159268 x 1



10159269 x 1



10159270 x 1

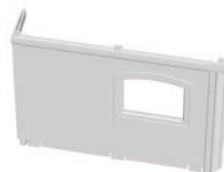

10159271 x 1



10155749 x 1



10131116 x 1



10131237 x 1



10131238 x 1



10110918 x 1



10155883 x 1



10159274 x 2



10159272 x 1



10159273 x 1



10159276 x 1



10159275 x 1



10131118 x 1



10155751 x 1



10159277 x 1



10155729 x 2



10155730 x 2



10159281 x 1

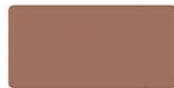

10131222 x 1



10159280 x 2



10131103 x 2



10160081 x 1

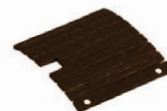

10160083 x 1

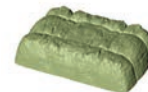

10155974 x 2



10129702 x1



10129700 x1



10129699 x1



10159282 x1



10129785 x1



10117365 x1



10117366 x1



10156043 x2



10117985 x1



10133516 x2



10133515 x2



10117303 x2



10117302 x2



10131164 x2



10161208 x1



10161209 x1



10153628 x1



10132771 x2



10160087 x1



10160085 x1

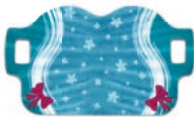

10160088 x1



10159904 x1



10159903 x1



10160074 x1



10159225 x1



10159228 x1



10162422 x1



10160071 x2



10160072 x1



10133892 x1



10114151 x1  
10114147 x1



10159279 x1



10159278 x1



10159899 x1



10159900 x1



10159231 x1



10159230 x1



10160090 x1



10156186 x1



10155977 x1

1

click

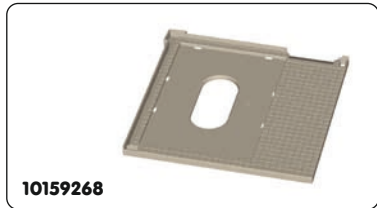
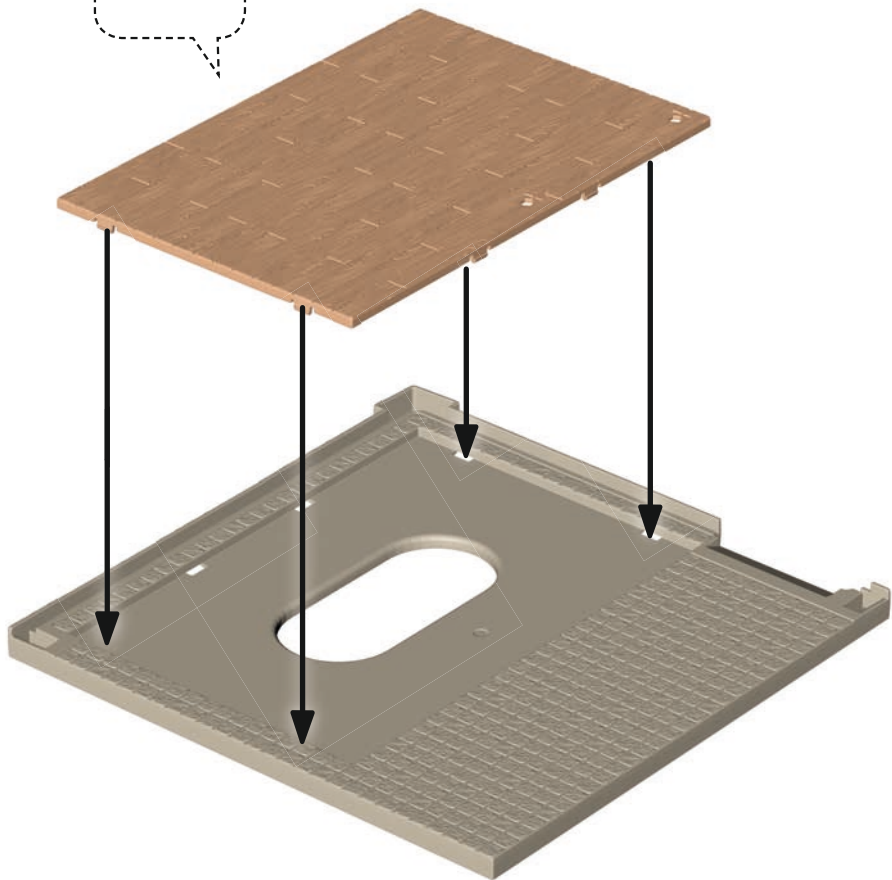

**2**

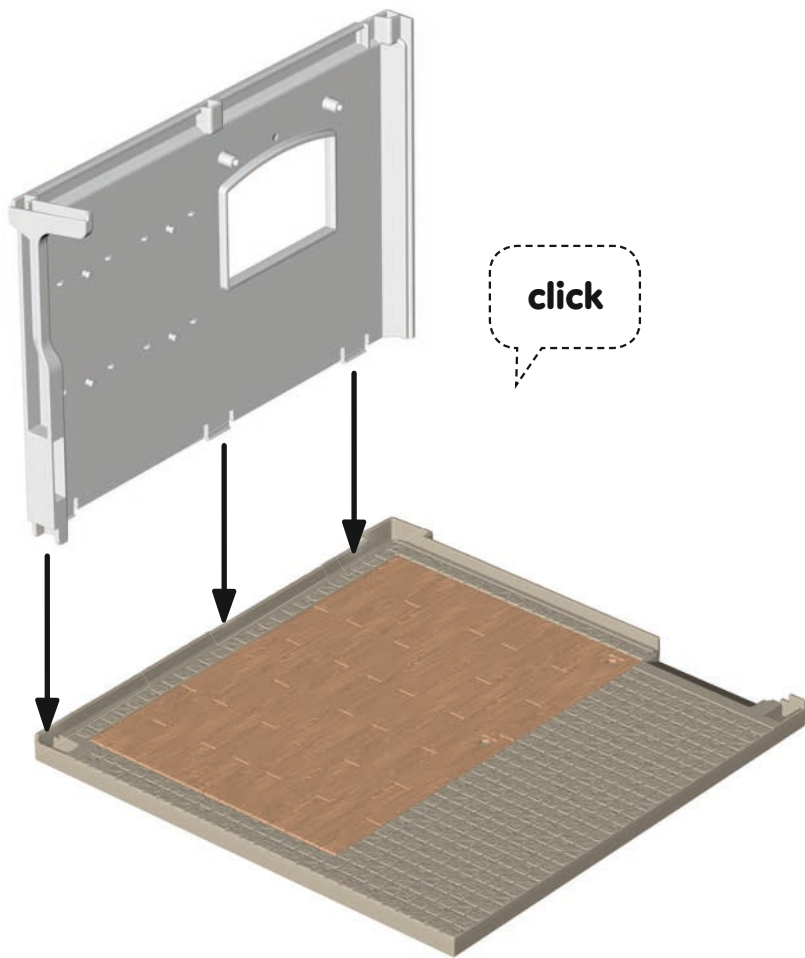

10159271



**3**

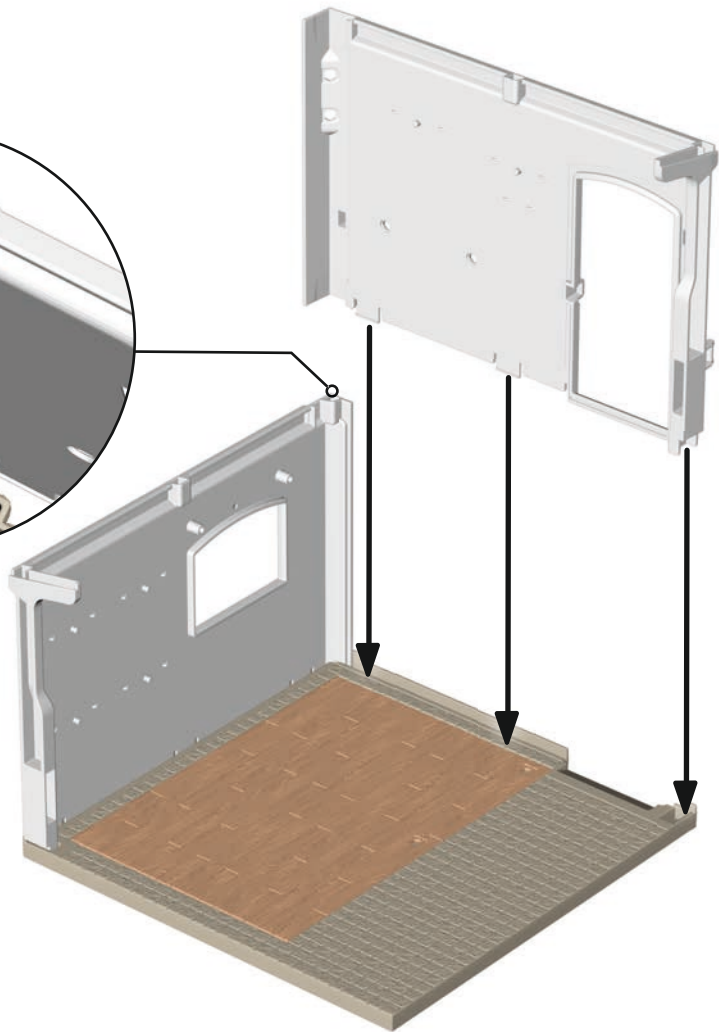
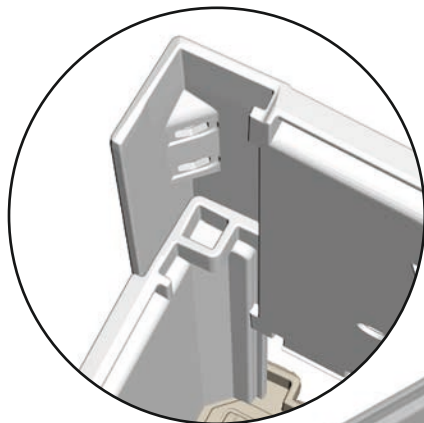

**click**

4

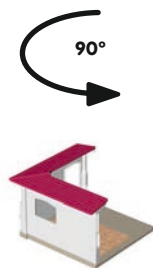
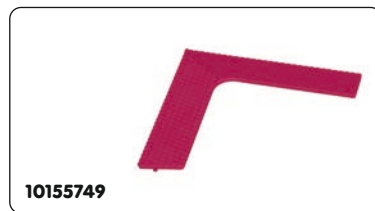
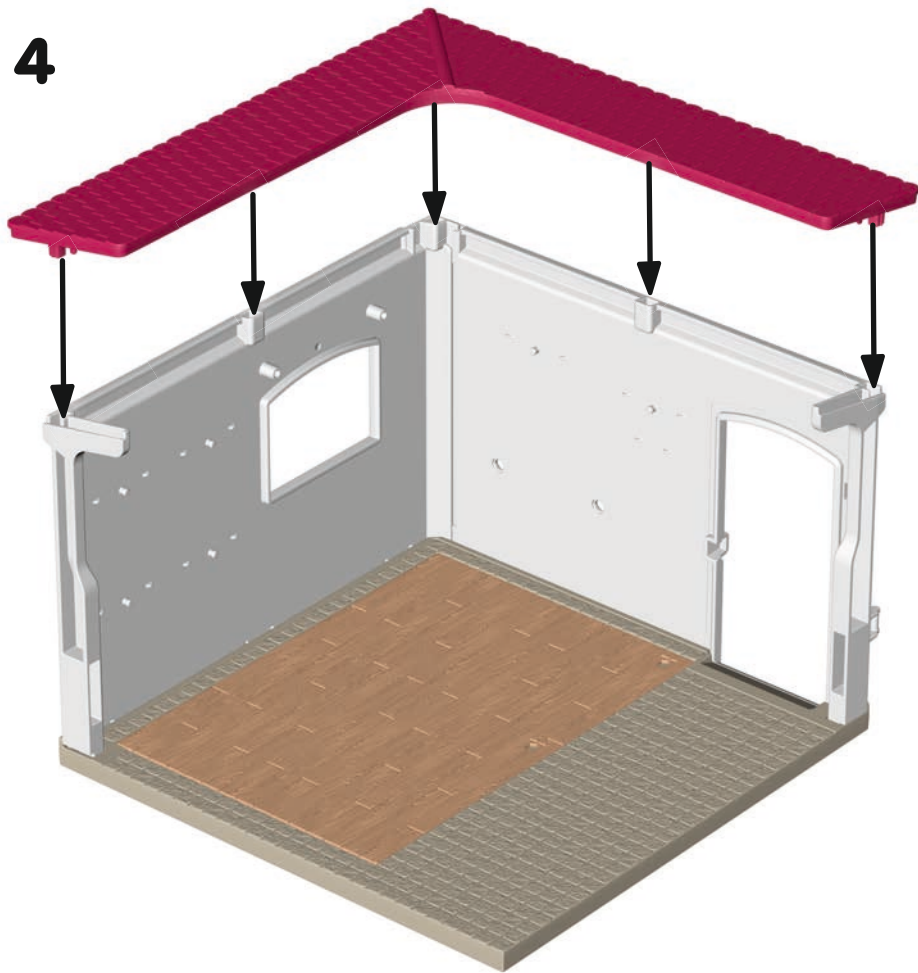

5

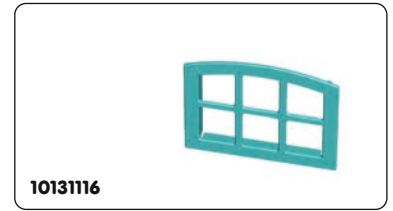
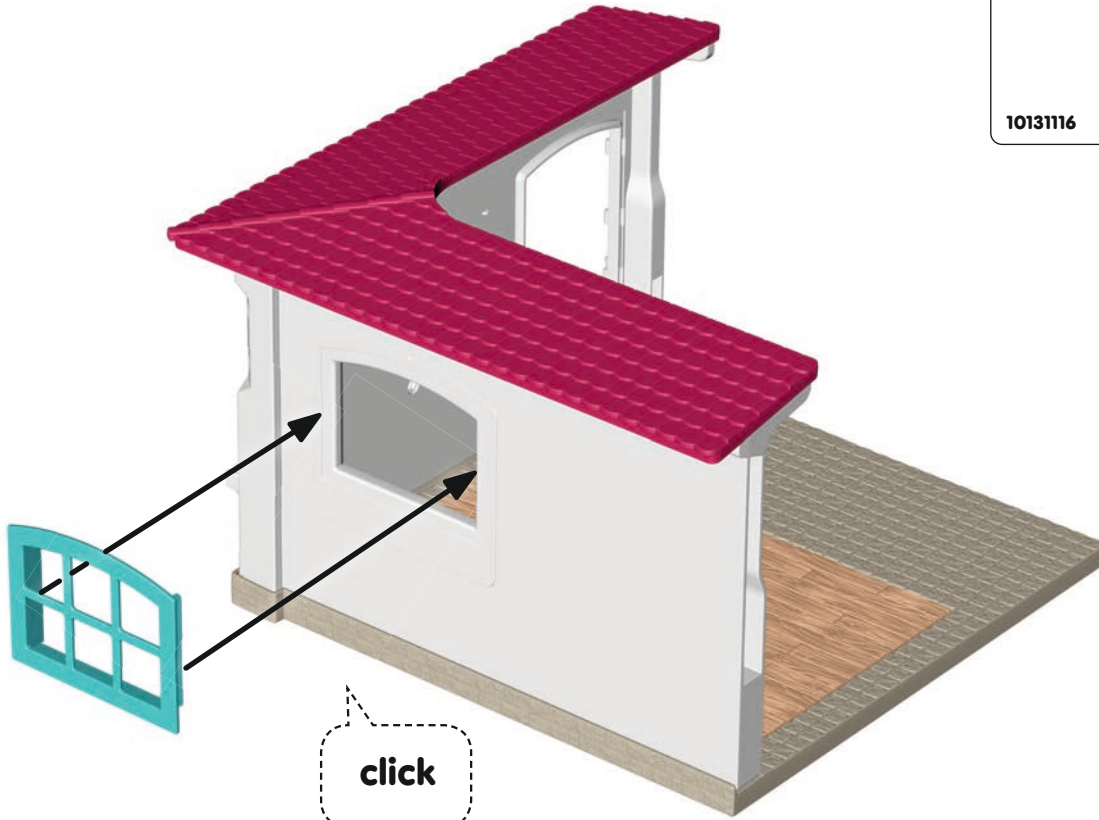



6

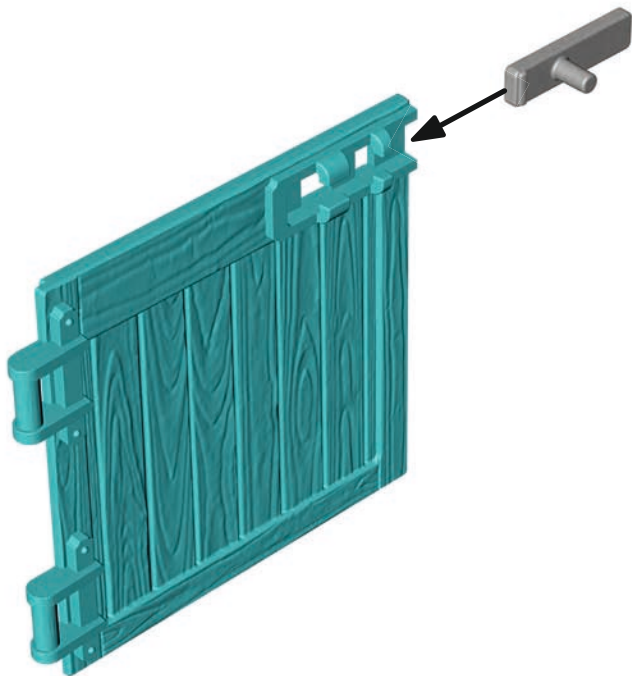

10110918

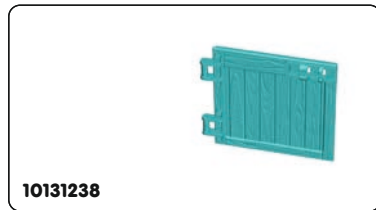

10131238

7

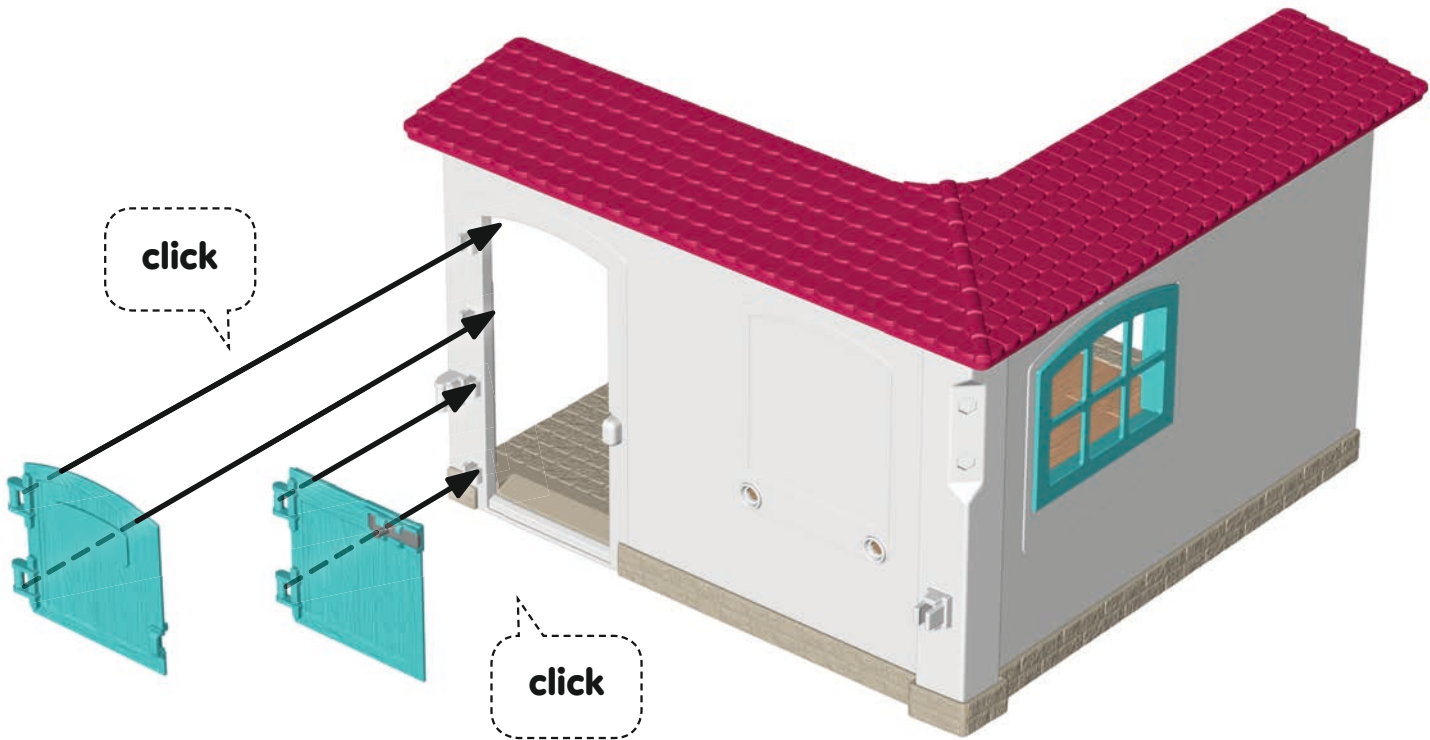
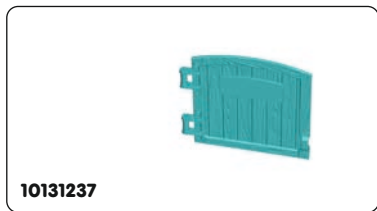

8

click

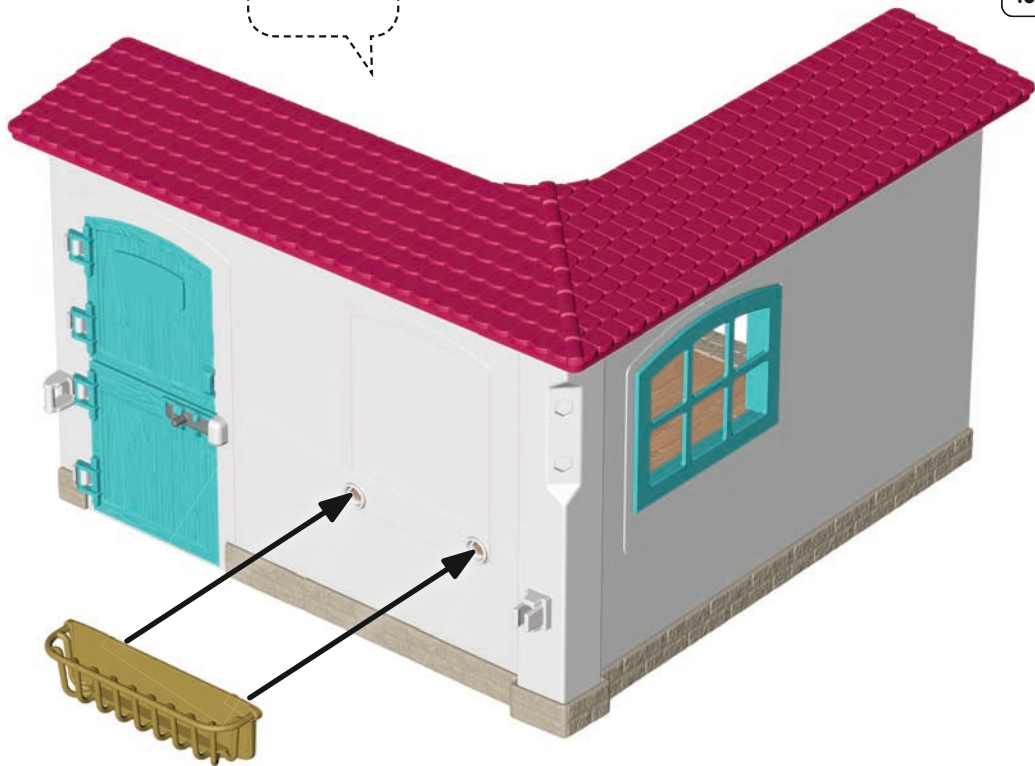
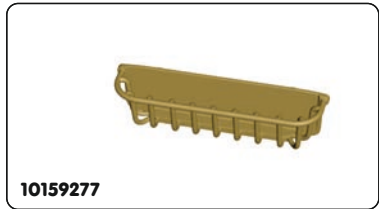

9

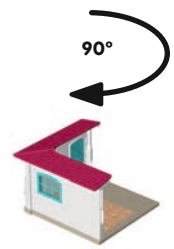
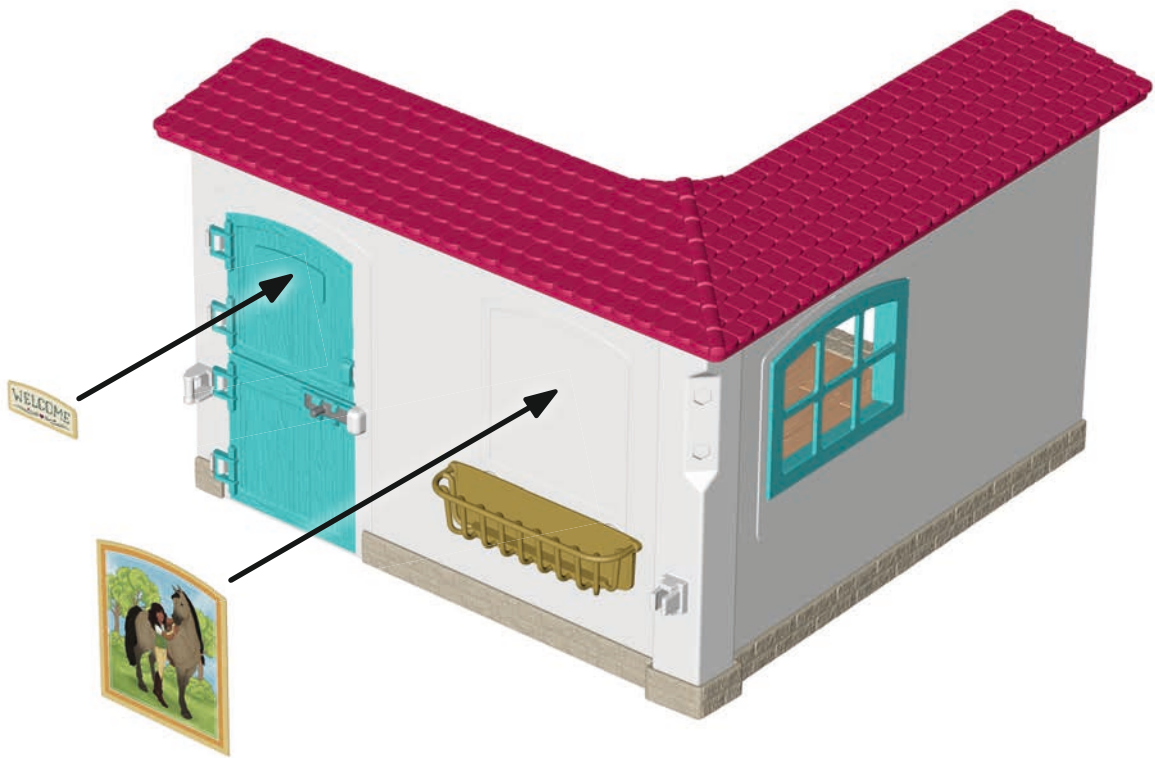

10

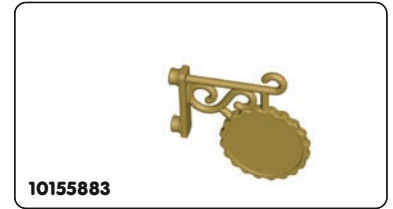
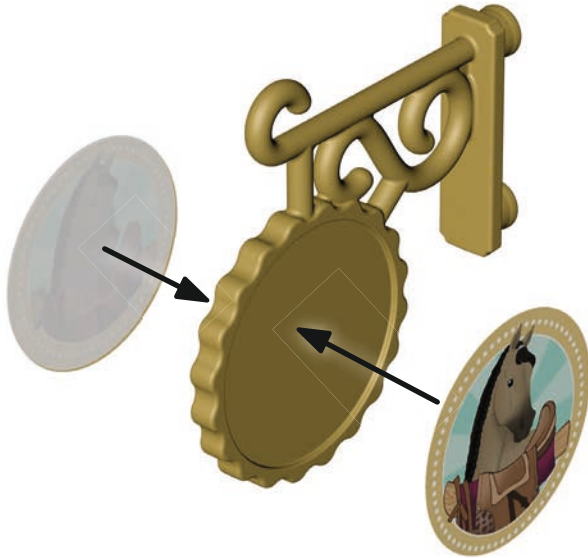

10155883



10162422

11

click

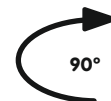
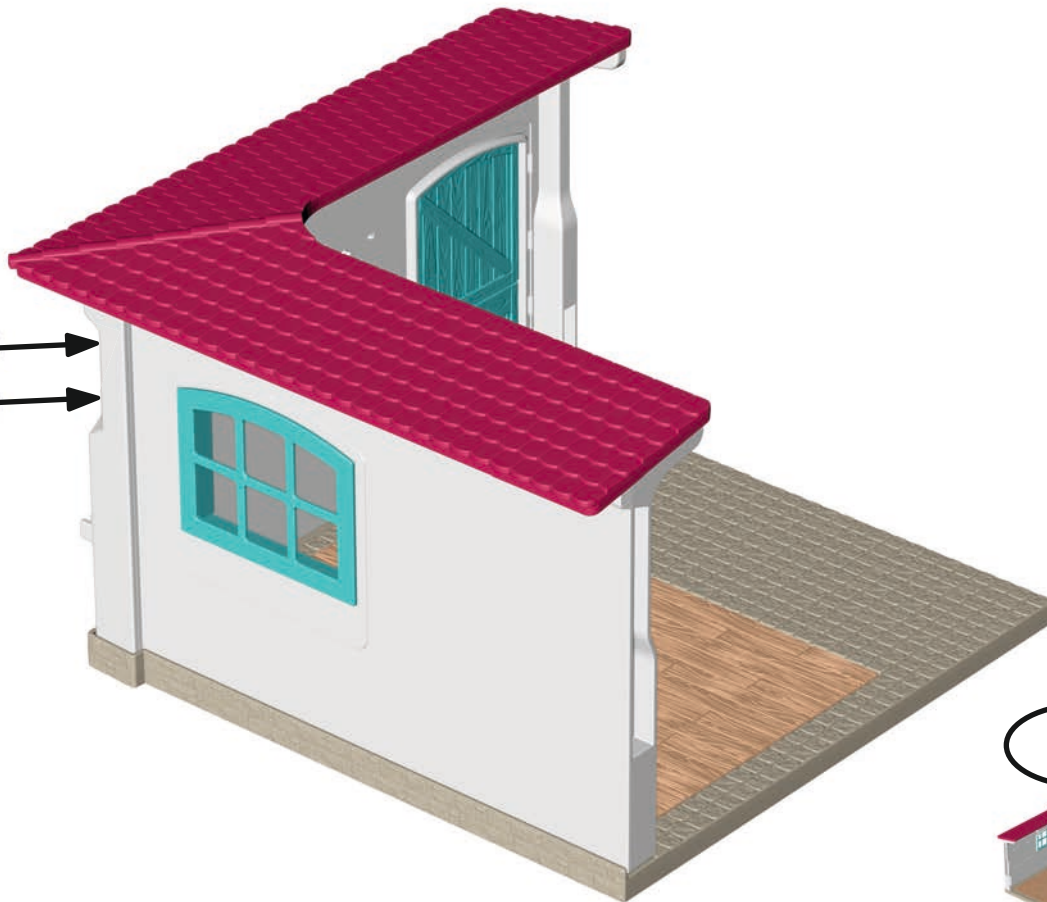

12

click

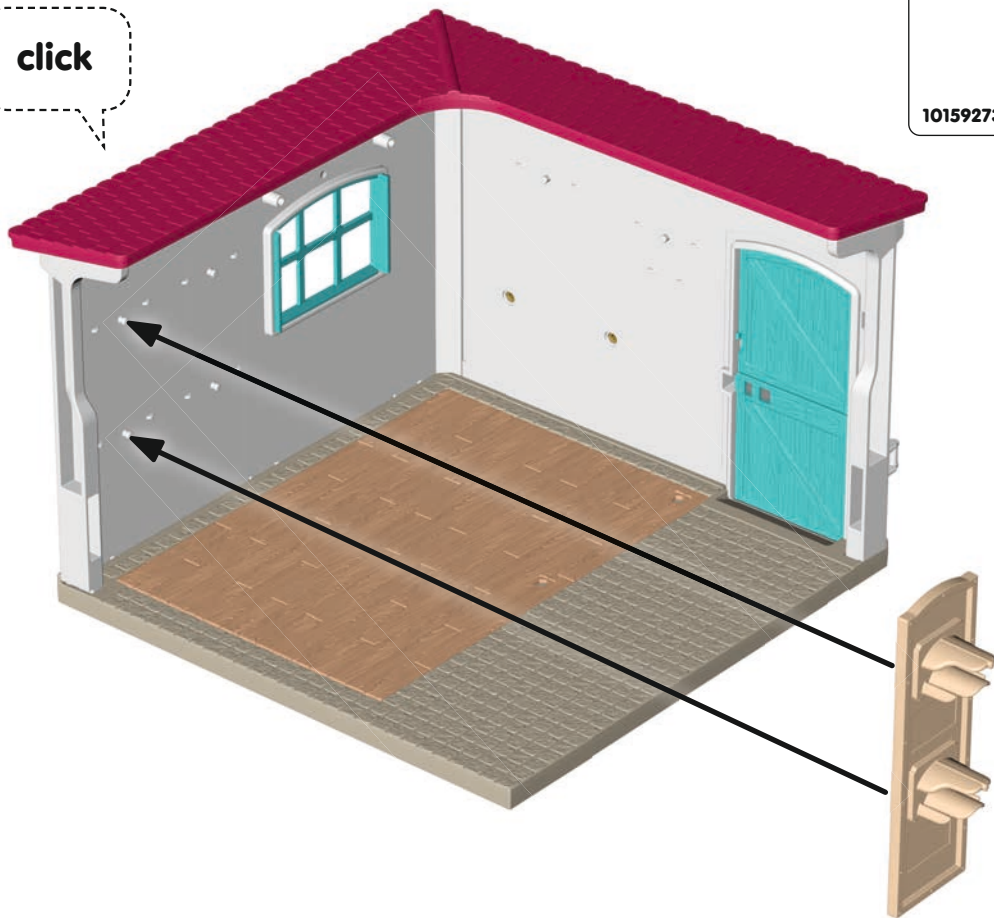

10159273

13

click

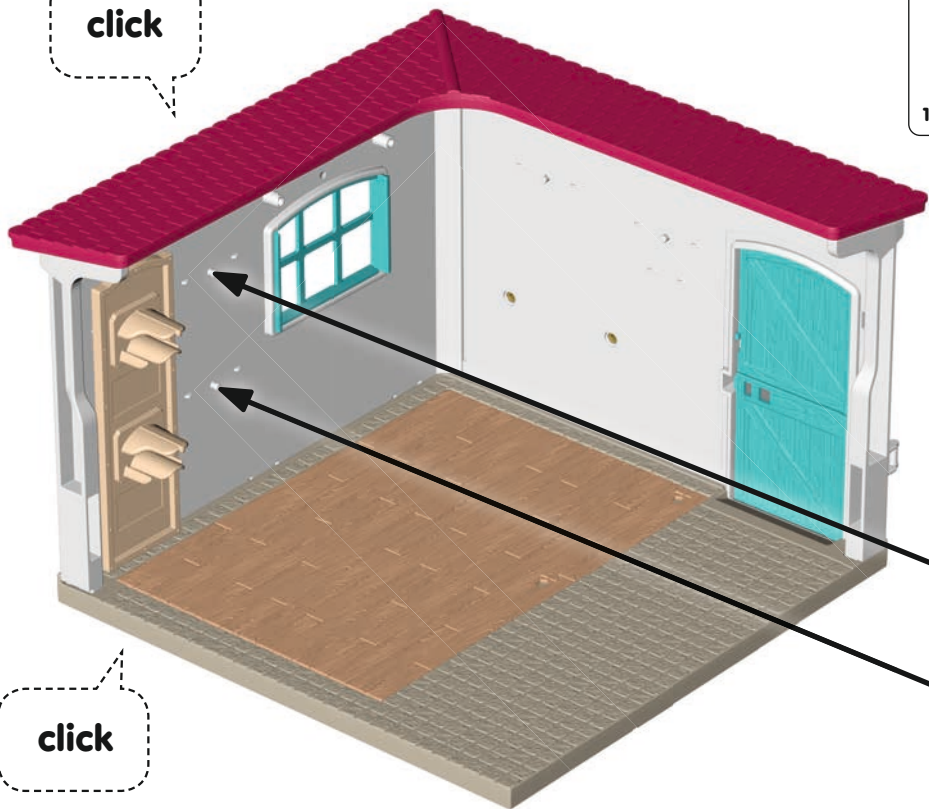

click



2x

10159274



14

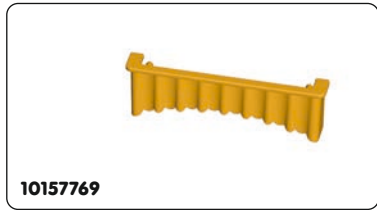
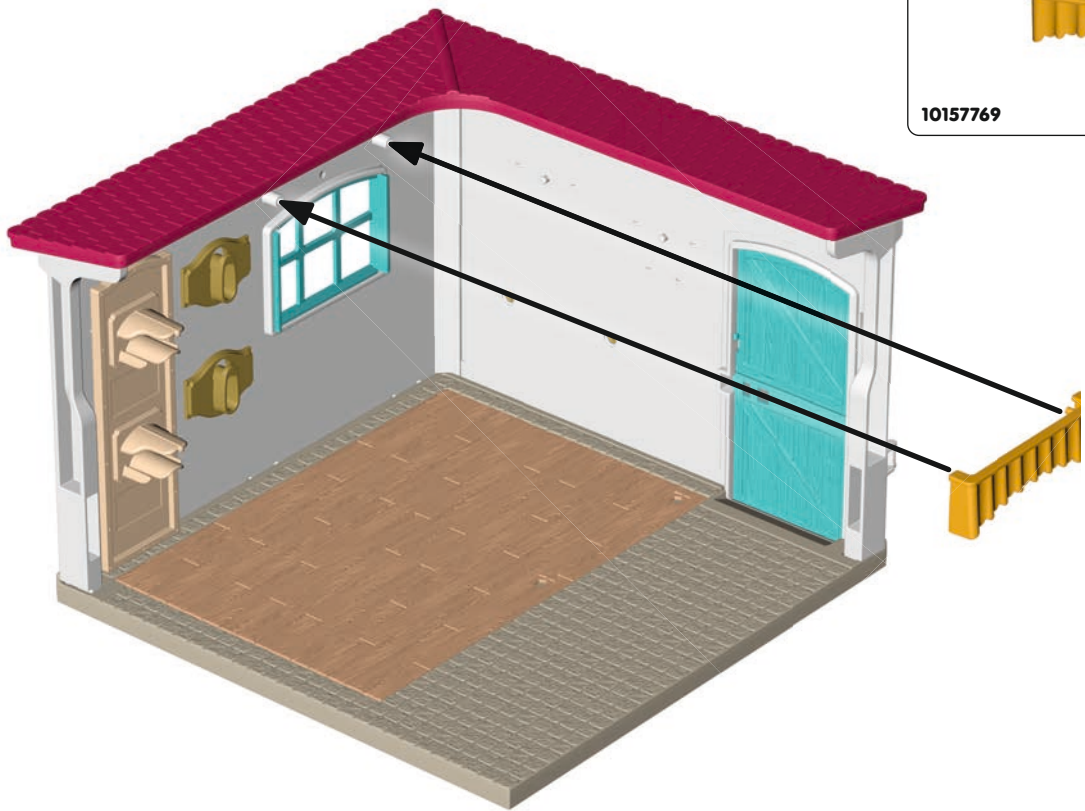

15

click

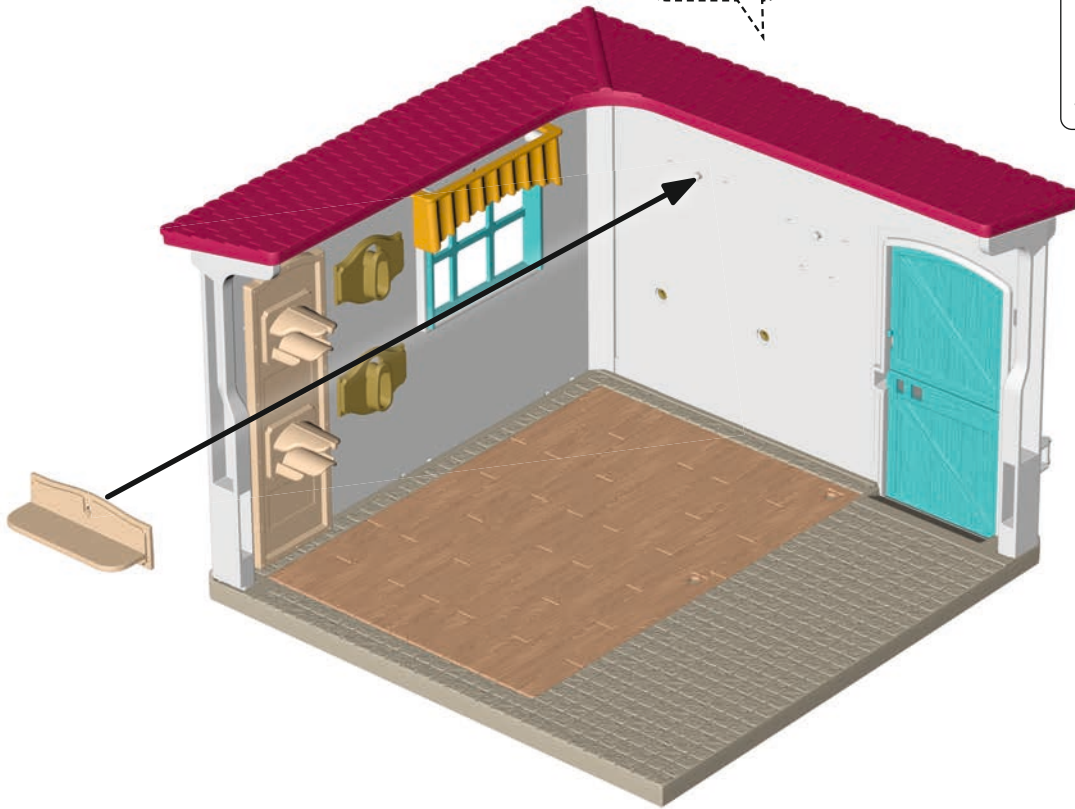

10159275

16

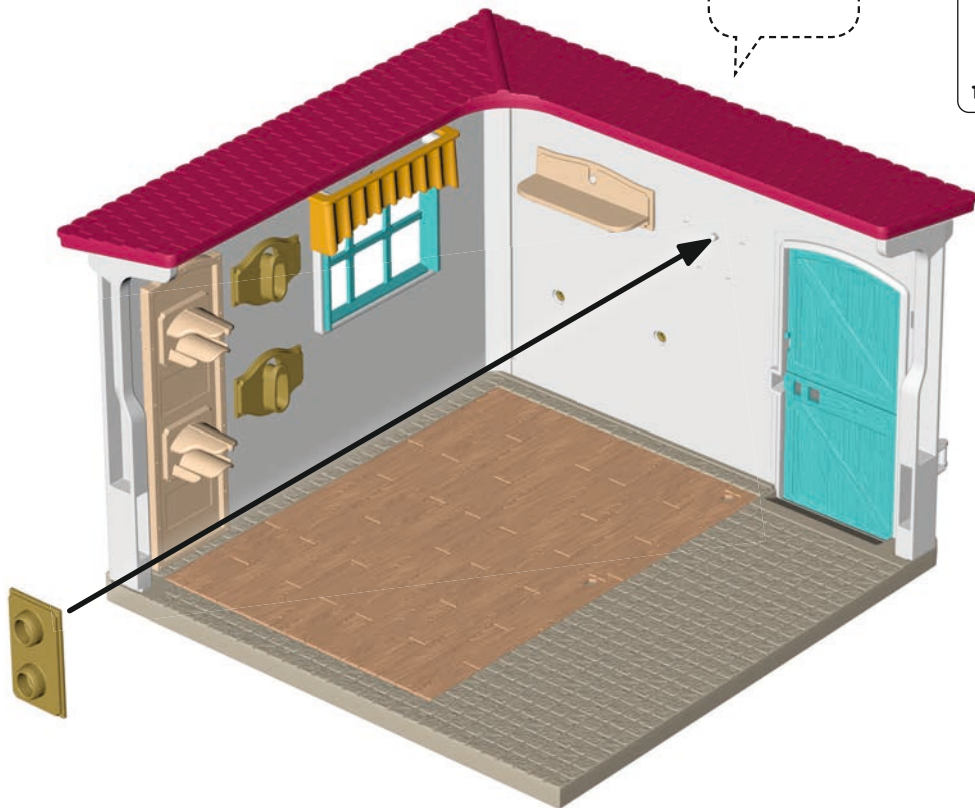

10159272



17

click

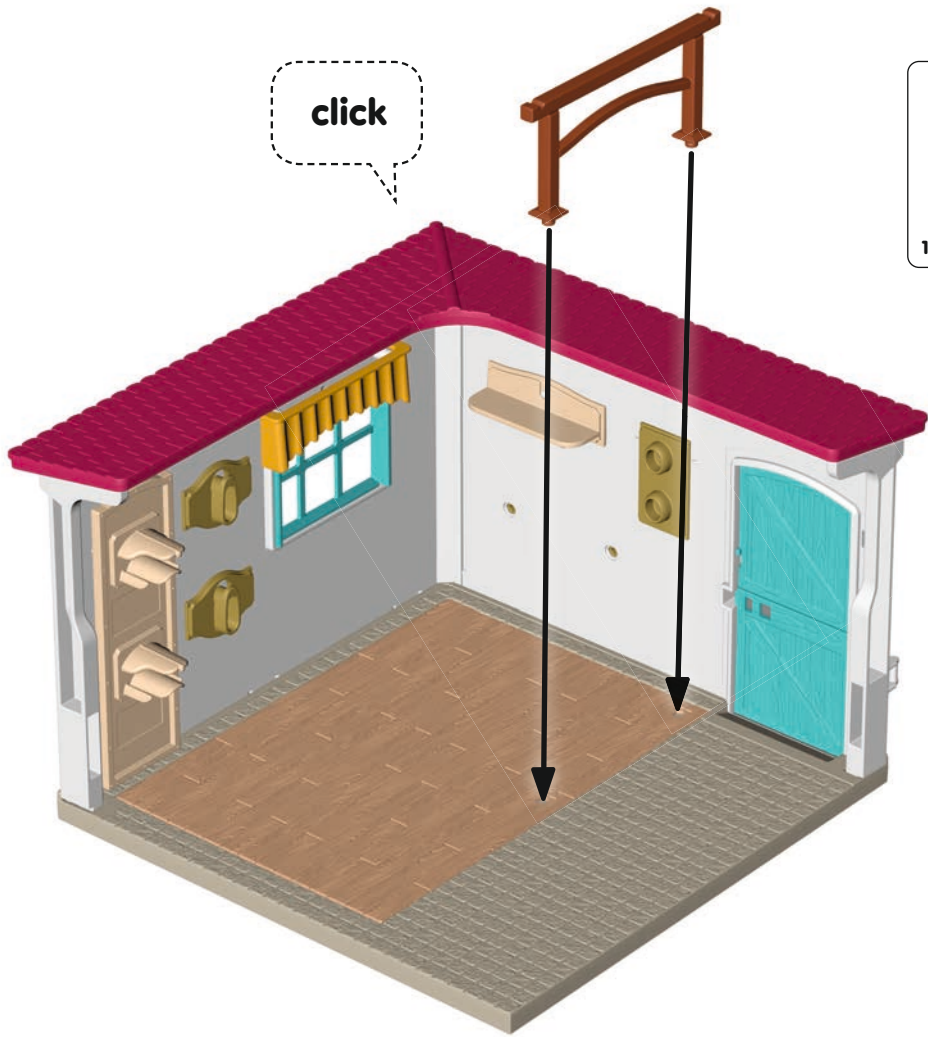

10155751

18

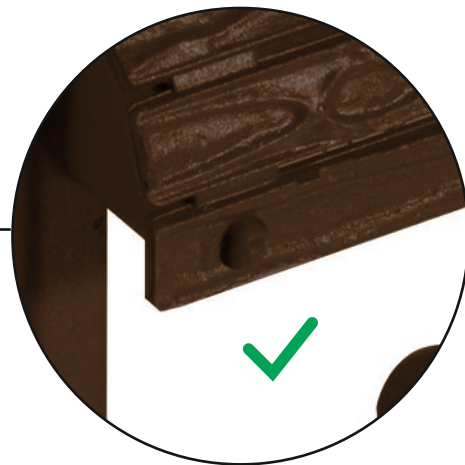

19



20

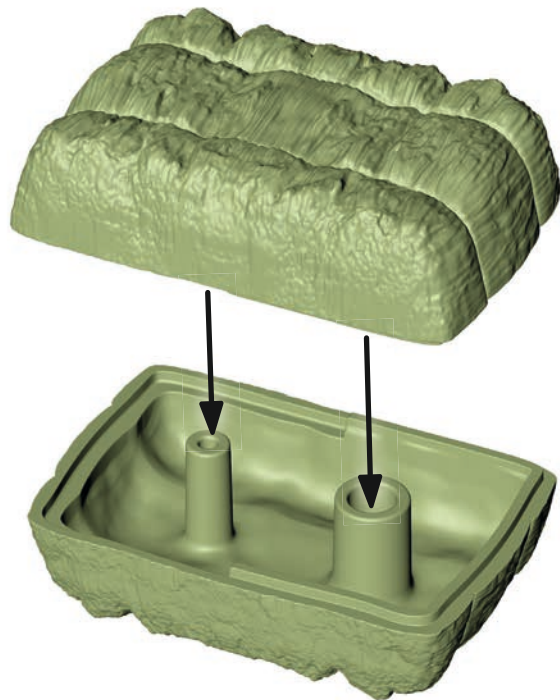

**21**

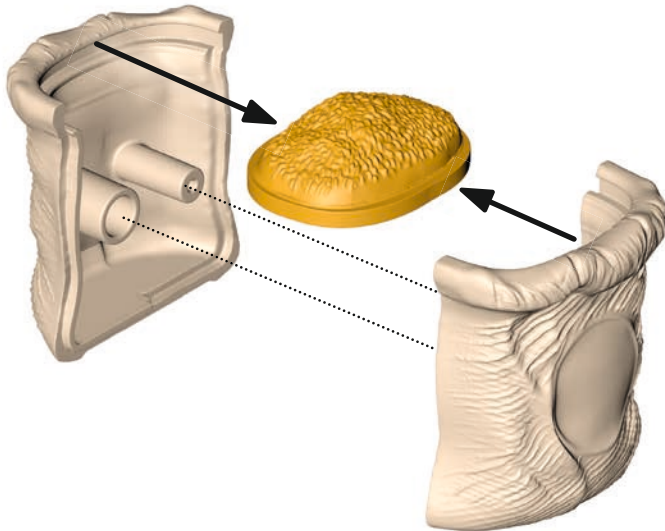



**22**

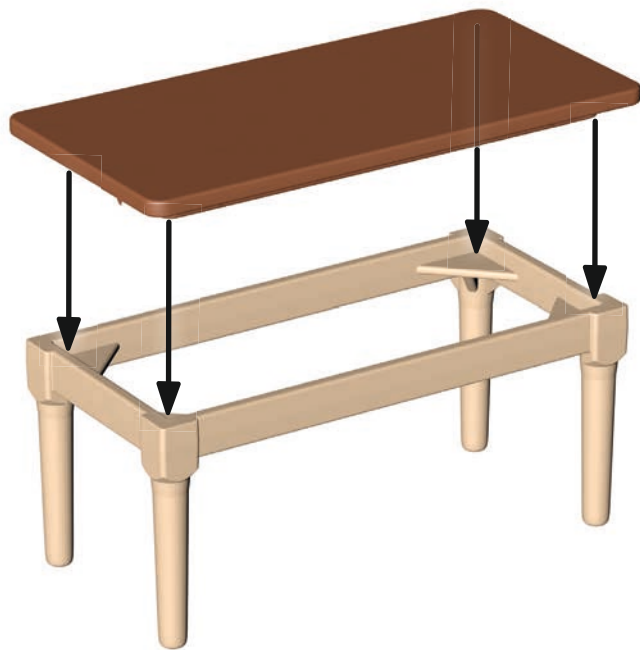

**10159281**

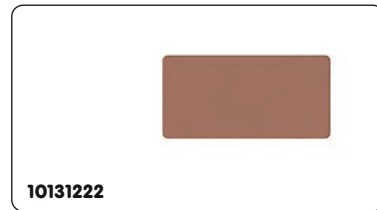

**10131222**

**23**

**2x**

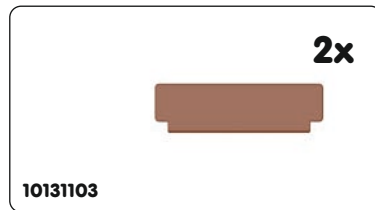
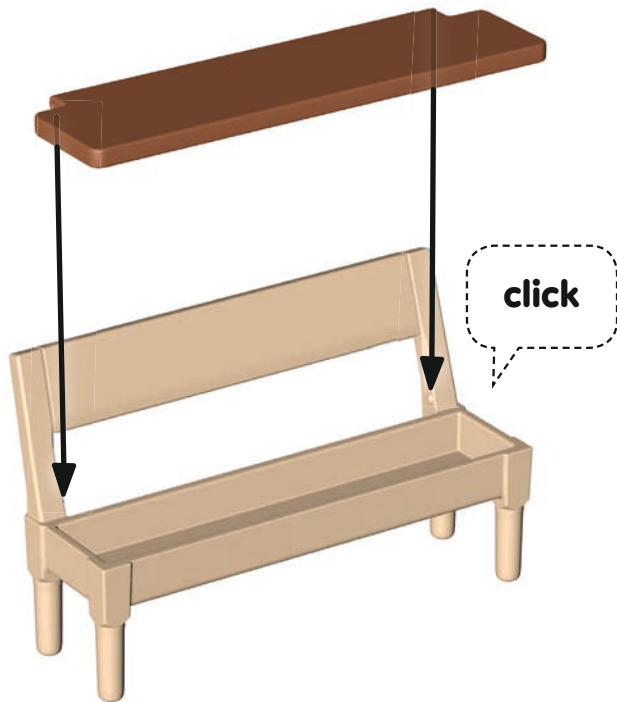

24

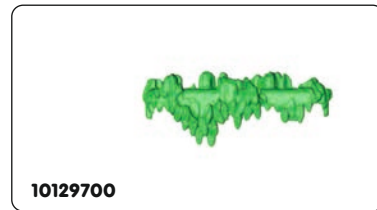
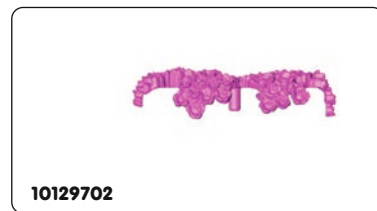
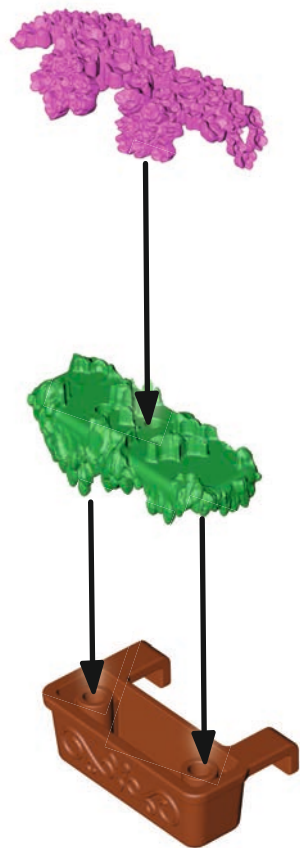

25

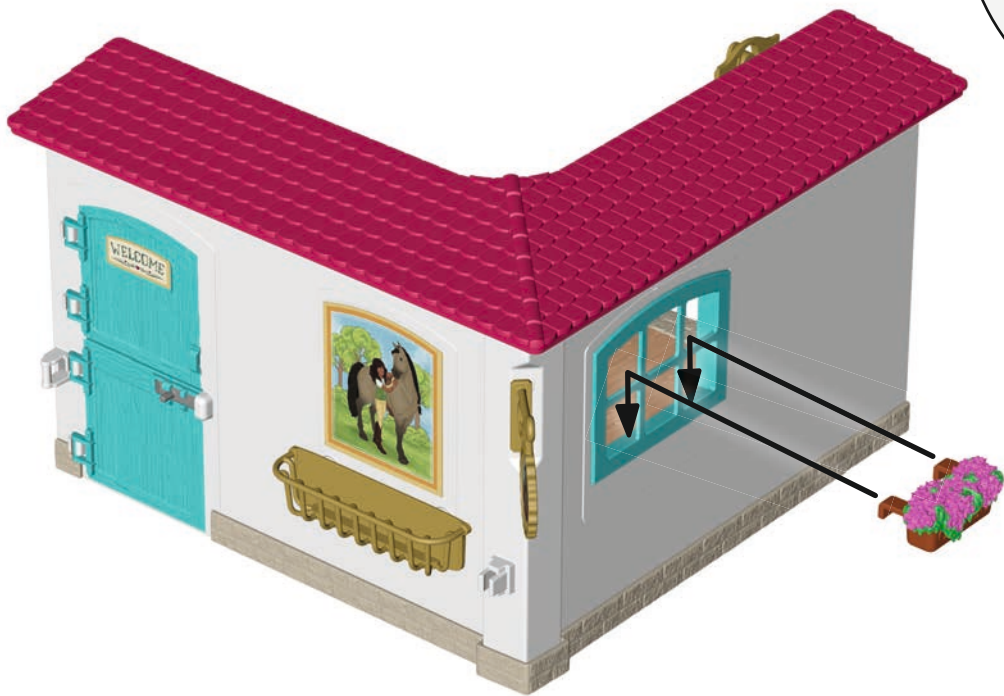

26

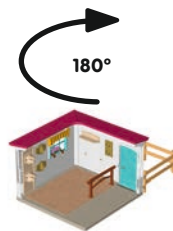
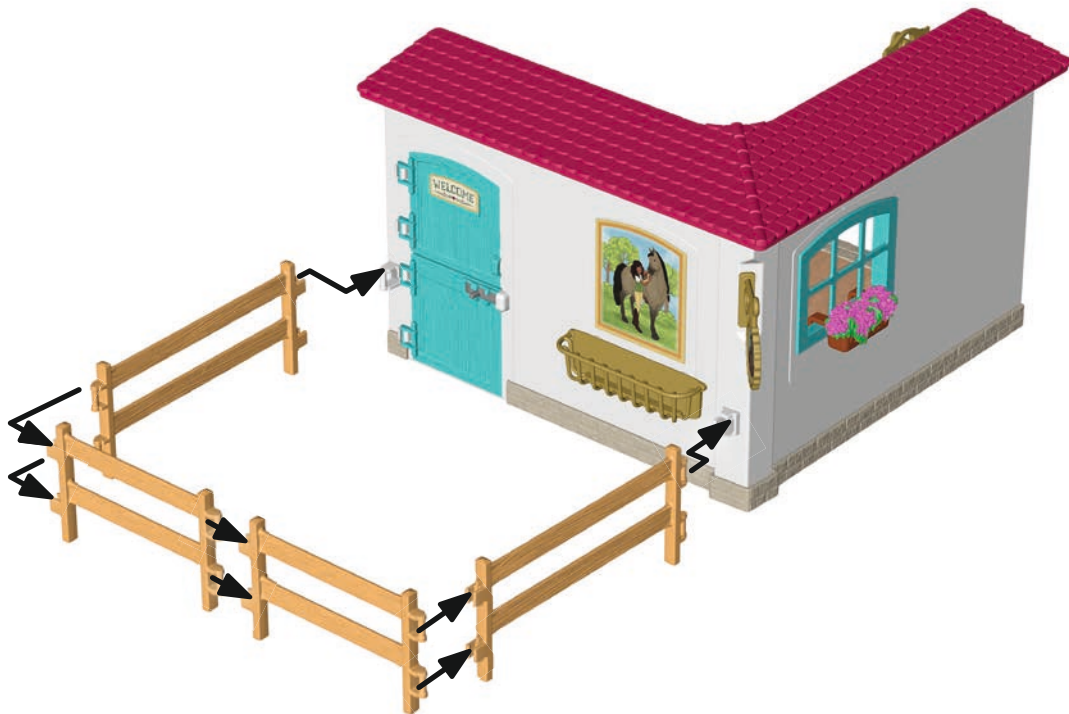

27



28



# 29

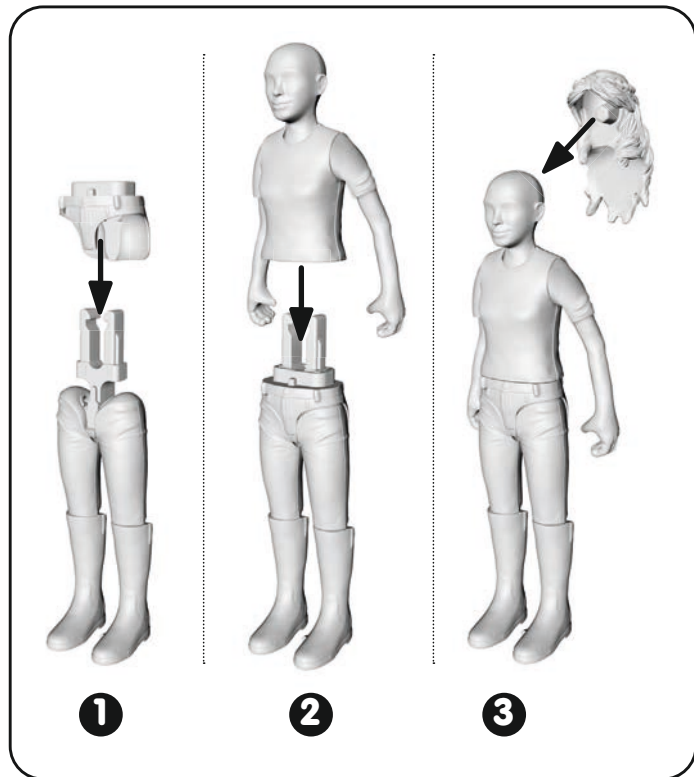











HORSE CLUB



schleich



42567



42568



42611

[www.schleich-s.com/stories](http://www.schleich-s.com/stories)



Photo by Mitchel Wu



Addison, 12



Mandi, 11



Rosa, 9



YouTube

[www.schleich-s.com](http://www.schleich-s.com)